

11G & 20G





恭喜您拥有贝伦斯BEHRENS腕表作品!

现在,我们将引导您开始使用和佩戴腕表。

## 开始使用和佩戴

“惊鸿之笏”是一枚搭载贝伦斯BEHRENS自研手动机械机芯的腕表。

无论您面前的腕表此刻是否在正常走时，在开始使用和佩戴前，都建议您先通过手动给表冠上链的方式让腕表增加走时动力，以确保腕表在接下来的使用过程中能保持正常运作和走时精准。

上链方式：将表冠顺时针旋转，直至表盘左上角的动力储备显示装置显示腕表有足够动力。

贝伦斯BEHRENS坚持原创、坚守高品质，每一枚腕表都经过官方内部严格的品质认证。

贝伦斯BEHRENS全线腕表的出厂走时标准为“整表±15s/天”内，部分型号表款为“±10s/天”。

“惊鸿之笏”腕表同样符合贝伦斯BEHRENS“整表±15s/天”内的企业标准。

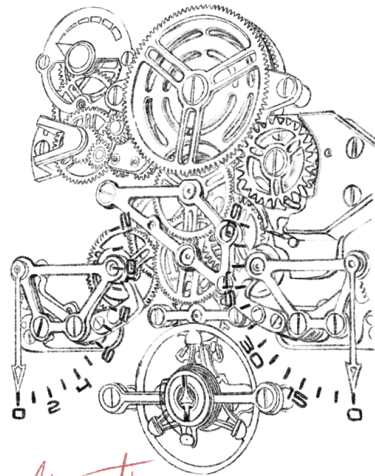

*Movement*

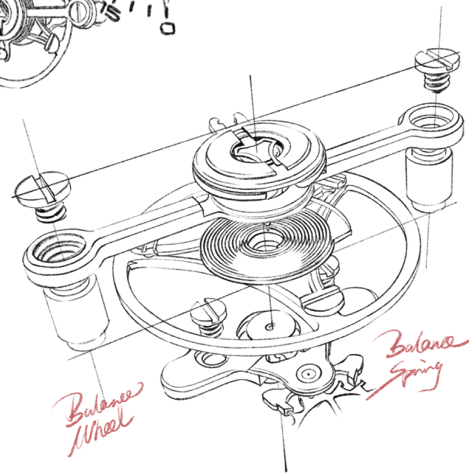
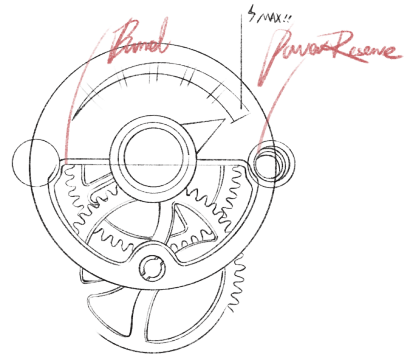

*Balance Wheel*

*Balance Spring*

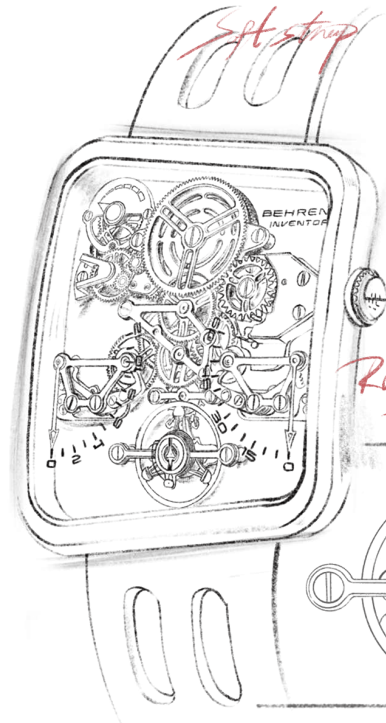

*Soft strap*

*Ruby*

*Sapphire Crystal*

*Case top*

*Case back*

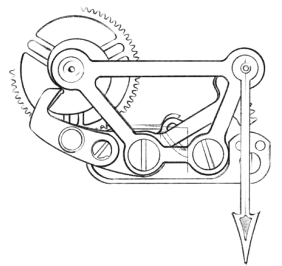
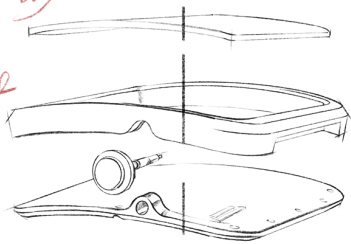

## 目录

关于“惊鸿之笏”	08
腕表使用说明	09
保养售后	12
THE HEART OF THE ULTRA-LIGHT	22
USING YOUR WATCH	23
BEHRENS SERVICE	26
關於“驚鴻之笏”	36
腕錶使用說明	37
保養售後	40

## 惊鸿之笏 11G/20G

“惊鸿之笏”是贝伦斯BEHRENS品牌“创想家INVENTOR”系列的表款，这是一个充分展现贝伦斯BEHRENS惊人创造力、研发和制表能力的系列。

“惊鸿之笏”设计灵感源于中国古代大臣上殿面君时的工具笏板。这是一种中国古代文武大臣上朝时使用的用以记录君命或旨意的工具，有时也会将要对君王上奏的内容记录在笏板上，以防遗忘。

腕表突破了传统机械表的重量桎梏，做到了至轻如鸿。全新自研“BM02”机芯，将表壳和机芯融为一体，让所有部件在非平面上实现完美传动，展现了贝伦斯登峰造极的制表能力。同时，“笏形”表壳更加符合人体工学，使佩戴更为舒适。

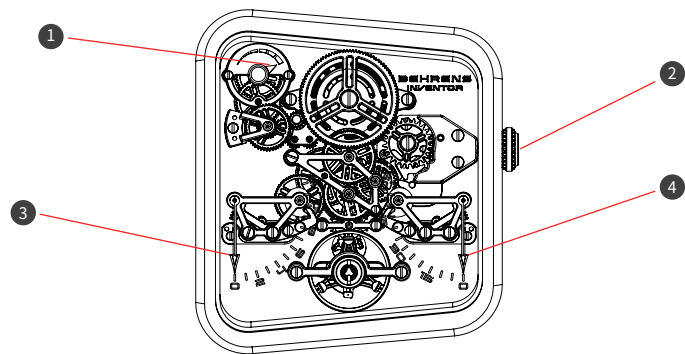

- |   |    |   |    |
|---|----|---|----|
| ① | 动储 | ② | 表冠 |
| ③ | 小时 | ④ | 分钟 |

## 惊鸿之笏调校方法

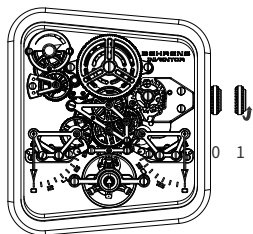

0 - 初始位置      1 - 调教时间

### 初始位置 (位置 0)

表冠正常情况下处于此位置时, 该状态下可确保腕表防水30米。

### 手动上链 (位置 0)

手动顺时针旋转表冠便可给腕表上链, 逆时针旋转是无效操作, 无法为腕表提供动力。如腕表已停止运作或是首次调校, 旋转表冠直至表盘左上角动力储备显示装置显示腕表有足够动力。

### 调校时间 (位置 1)

轻轻拉出表冠并至位置 1, 顺时针旋转即可调校分钟及小时时间。

10 注: 该腕表没有日历功能; 确保正常使用时表冠处于“位置0”, 以免影响防水和走时。

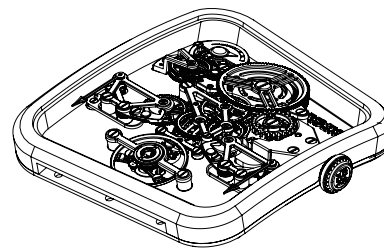

贝伦斯BM02机心

### 规格:

零件数: 242件      宝石数: 41颗  
厚度: 5.2MM      振 频: 28800A/H (4Hz)

### 特性:

手动上链机心      时, 分双逆跳显示  
腕表左上方动储显示, 38小时动储

## 表带系统

惊鸿之笏腕表的表带为固定式, 长度相同。  
如需更换请联系品牌官方协助操作。

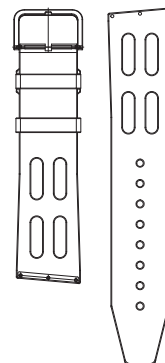



贝伦斯BEHRENS所有腕表从您购买之日起享有三年国际保修。此外，您还可以通过贝伦斯BEHRENS官方网站登记延保至5年。

当手表需要保修时，您必须出示保修卡才能享受保修服务，该卡必须在您购买手表时，由官方或授权的代理商正式填写才有效，包括售出日期和印章。

贝伦斯BEHRENS为全球范围内售出的腕表提供专业售后服务，确保腕表的走时可靠及防水性能。

目前，贝伦斯BEHRENS位于中国深圳的总部是唯一的全球售后服务中心，建议您定期将腕表送往贝伦斯BEHRENS服务中心接受专业的售后服务。

我们对每款手表的必备零件都备有库存，因此可以保证多年后对手表进行维修。以上的承诺适用于每一块贝伦斯BEHRENS手表，我们为我们产品的耐久性而自豪。

## 下列情况不属于免费保修范围:

- 1、遗失、盗窃或由于火灾、地震等其他灾害而导致的瑕疵和损坏;
- 2、由于误用、疏忽或因为意外事故而导致的瑕疵和损坏;
- 3、由于不正当使用(敲打、撞击、挤压等),擅自改动或未经由贝伦斯BEHRENS授权的任何人修理,或因使用贝伦斯BEHRENS未建议的零件而导致的瑕疵和损坏;
- 4、由于正常磨损而产生的瑕疵和损坏;为确保本国际保修的有效性,对该表所做的任何维护与修理均由贝伦斯BEHRENS授权的维修中心进行。

## 保养注意事项

### ① 防水性能：

您的腕表在交付前已通过防水深达3巴以上的压力检查。这可确保腕表在溅到水或接触到大量水时受到保护。但是，您的腕表并不适合在洗澡、桑拿等情况下使用，否则可能会造成进水。

### ② 避免撞击：

机械腕表为精密的智慧杰作，并非越高价越坚不可摧。相反，越精密的机械腕表越容易收到影响。因此，佩戴腕表时，应避免剧烈撞击和震动。

### ③ 注意防磁：

磁场会影响腕表的正常性能。尽管磁场不会直接损害腕表，仍可能影响腕表的精准度，甚或导致腕表停止运转。最常见的磁场源自手机、磁性腕带、袋扣、扬声器、计算机和各种家用电器。这种情况属免费维修范围，贝伦斯可为腕表进行检查和消除磁场影响。

### ④ 避免刮碰：

如果您的腕表与手链、首饰或其他硬物触碰时，可能会在金属表壳留下刮痕，特别是K金表壳。

## 全球销售网络

贝伦斯BEHRENS特约零售商遍布全球，由具备专业知识及精湛技艺，且经过精心挑选的合作伙伴为您效劳。欢迎浏览 [behrenswatches.com](http://behrenswatches.com)了解我们的全球授权合作伙伴信息。

Congratulations on this unique masterpiece from BEHRENS.

Now let us walk you through the following information before wearing this timepiece.

对于本手册所刊载表款规格等信息, 贝伦斯BEHRENS保留修改权利。

7th floor, Yi'an Zhifu Building, intersection of Huangge Road and Qinghui Road, Longcheng Street, Longgang District, Shenzhen, China, 518172

[behrenswatches.com](http://behrenswatches.com)

## Getting Started and Wearing

The Ultra-Light 11G&20G collection is equipped with an all-new in-house designed and developed manual wind Cal. BM02 mechanical movement by BEHRENS.

Regardless of whether the watch in front of you is currently in normal working order, it is recommended that you manually chain the crown before starting to use and wear it.

Let the watch increase its timing power to ensure that it can maintain normal operation and accurate timing during subsequent use.

Chain up method: Rotate the crown clockwise until the power reserve display device in the upper left corner of the dial shows that the watch has sufficient power.

BEHRENS adheres to originality and high quality, and every watch undergoes strict internal quality certification from the official.

The factory running time standard for BEHRENS full line watches is within  $\pm 15\text{s/day}$  for the entire watch, and  $\pm 10\text{s/day}$  for some models.

The Ultra-Light 11G&20G wristwatches also meet the factory standard of 'whole Watch  $\pm 15\text{s/day}$ ' by BEHRENS.

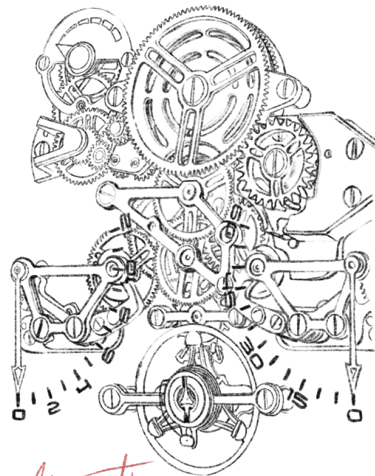

*Movement*

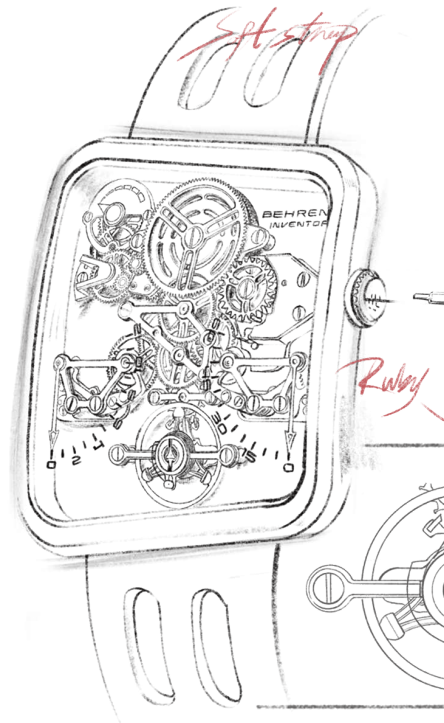
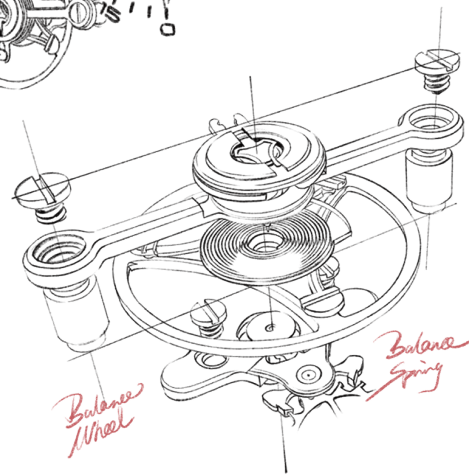
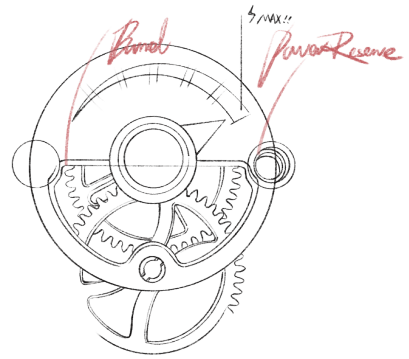

*Sapphire Crystal*



*Case top*



*Case back*

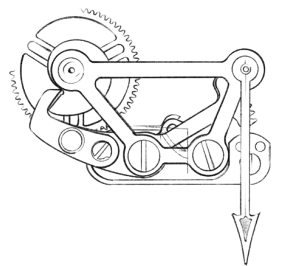
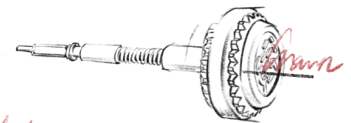
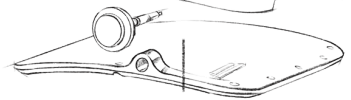

## Ultra-Light 11G&20G

The 11G&20G watches of the Ultra-Light are part of the BEHRENS INVENTOR series , showcasing Behrens' amazing creativity, research and development, and watchmaking abilities.

The design inspiration for the 11G&20G watches of the Ultra-Light is derived from the tool Wat board used by ancient Chinese ministers to meet the emperor in the palace. This is a tool used by ancient Chinese ministers of literature and martial arts to record the orders or intentions of the monarch when they went to court. Sometimes, they also record the content to be recited to the monarch on the Wat board to prevent forgetting.

Wristwatches have broken through the weight shackles of traditional mechanical watches . The new self-developed BM02 movement integrates the watch case and movement, allowing all components to achieve perfect transmission on non flat surfaces, showcasing BEHRENS' exceptional watchmaking ability. At the same time, the Wat shaped design of the watch case is more ergonomic, making it more comfortable to wear.

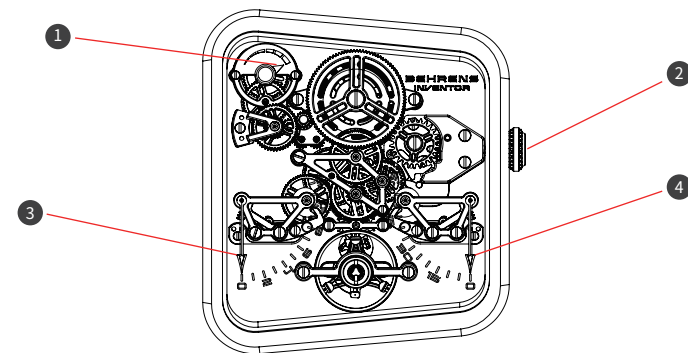

- |   |               |   |        |
|---|---------------|---|--------|
| 1 | Power reserve | 2 | Crown  |
| 3 | Hour          | 4 | Minute |

## SETTING THE WATCH

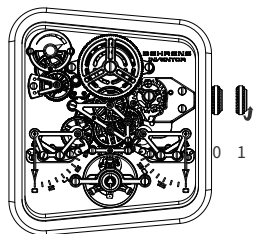

0-Initial position

1-Setting the reference time (crown in position 1)

### Initial position (crown in position 0)

When the crown is in this position under normal circumstances, it can ensure that the watch is waterproof for 30 meters.

### Manual winding (crown in position 0)

To wind the watch manually, turn the crown clockwise. (Turning in the other direction has no effect.) When setting the watch for the first time or after the watch has stopped, rotate the crown of the watch until the power reserve display device in the upper left corner of the dial indicates that the watch has sufficient power.

### Setting the reference time (crown in position 1)

Gently pull out the crown and move it to position 1, rotate clockwise to adjust the minutes and hours.

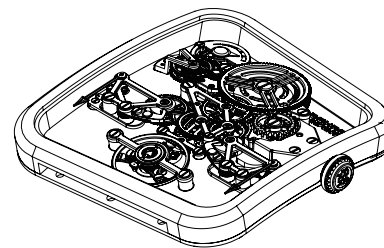

Calibre BM02

### Specification:

Parts: 242

Jewels: 41

Thickness: 5.2MM Frequency: 28800A/H (4Hz)

### Characteristic:

Manual winding movement

Time and minute dual Retrograde display

38 hour power reserve display

## Bracelet/strap

The strap is fixed and has a uniform length.

If you need to replace the watch strap, please contact the official for assistance.

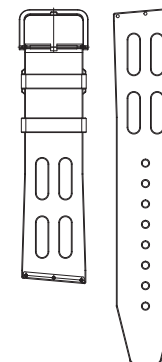

Each Behrens watch comes with an international warranty of three years from the date of purchase.

In addition, you can register for an extension of 5 years through the official website of Behrens.

When the watch requires a warranty, you must present the warranty card to enjoy the warranty service, which must be officially filled in by an official or authorized agent at the time of your purchase of the watch to be valid, including the date of sale and the seal.

Behrens provides professional after-sales service for watches sold around the world to ensure the reliability and waterproof performance of watches.

At present, the headquarters of Behrens in Shenzhen, China is the only global after-sales service center, and it is recommended that you regularly send your watch to the Behrens service center to receive professional after-sales service.

We stock the essential parts for each watch, so we can guarantee that the watch will be repaired after many years. The above commitment applies to every Behrens watch and we pride ourselves on the durability of our creations.

### **The following situations are not covered by the free warranty:**

1. Loss, theft or defects and damage caused by fire, earthquake and other disasters;
2. Defects and damage caused by misuse, negligence or accidents;
3. Defects and damage caused by improper use (knocking, impact, crushing, etc.), unauthorized alteration or repair by anyone authorized by Behrens, or the use of parts not recommended by Behrens;
4. Defects and damage due to normal wear and tear.



## Maintenance precautions

### 1 Waterproof:

Your watch has passed a pressure check with a waterproof depth of over 3 bars before delivery. This ensures that the watch is protected from splashing or coming into contact with a large amount of water. However, your watch is not suitable for use in bathing, sauna, or other situations, as it may cause water ingress.

### 2 Avoiding impact:

A mechanical watch is a precise and intelligent masterpiece, and the higher the price, the more indestructible it is. On the contrary, the more precise a mechanical watch, the more susceptible it is to impact. Therefore, when wearing a watch, it is important to avoid severe impact and vibration.

### 3 Anti magnetic:

A magnetic field can affect the normal performance of a watch. Although magnetic fields do not directly damage the watch, they may still affect its accuracy or even cause the watch to stop working. The most common magnetic fields come from mobile phones, magnetic wristbands, bag buckles, speakers, computers, and various household appliances. This situation belongs to the scope of free maintenance, and Berence can inspect and eliminate the influence of magnetic fields on the watch.

### 4 Avoid scratching:

If your watch touches a bracelet, jewelry, or other hard object, it may leave scratches on the metal case, especially the gold case.

## Global sales channels

BEHRENS authorized retailers are located worldwide, with carefully selected partners who possess professional knowledge and exquisite craftsmanship to serve you.

Welcome to [Behrenswatches.com](https://www.behrenswatches.com) to learn about our global authorized partner information.

恭喜您擁有貝倫斯BEHRENS腕錶作品!

現在,我們將引導您開始使用和佩戴腕錶。

BEHRENS reserves the right to modify the specifications and other information of the tables published in this manual.

7th floor, Yi'an Zhifu Building, intersection of Huangge Road and Qinghui Road, Longcheng Street, Longgang District, Shenzhen, China,518172

[behrenswatches.com](http://behrenswatches.com)

## 開始使用和佩戴

“驚鴻之笏”是一枚搭載貝倫斯BEHRENS自研手動機械機心的腕錶。

無論您面前的腕錶此刻是否在正常走時，在開始使用和佩戴前，都建議您先通過手動給錶冠上鍊的方式讓腕錶增加走時動力，以確保腕表在接下來的使用過程中能保持正常運作和走時精準。

上鍊方式：將錶冠順時針旋轉，直至錶盤左上角的動力儲備顯示裝置顯示腕錶有足夠動力。

貝倫斯BEHRENS堅持原創、堅守高品質，每一枚腕錶都經過官方內部嚴格的品質認證。

貝倫斯BEHRENS全線腕錶的出厂走時標準為「整錶±15s/天」內，部分機型錶款為「±10s/天」。

「驚鴻之笏」腕錶同樣符合貝倫斯BEHRENS「整錶±15s/天」內的企業標準。

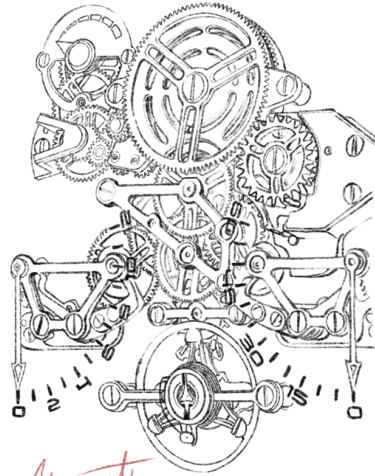

*Movement*

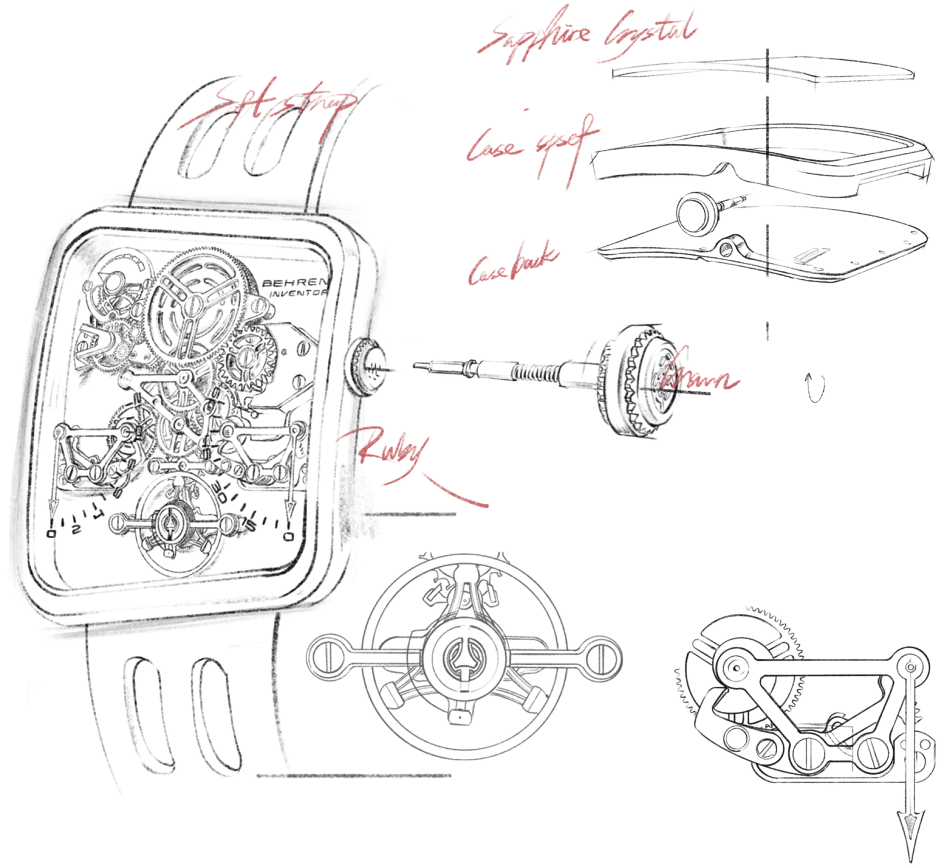
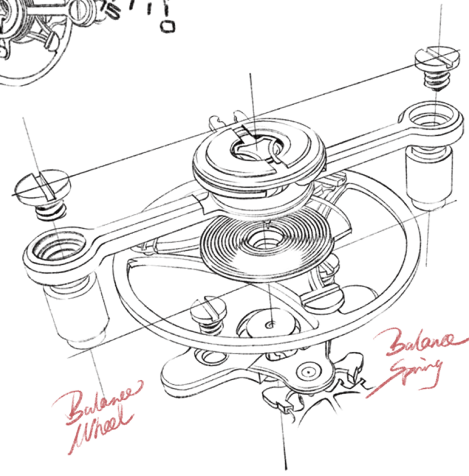
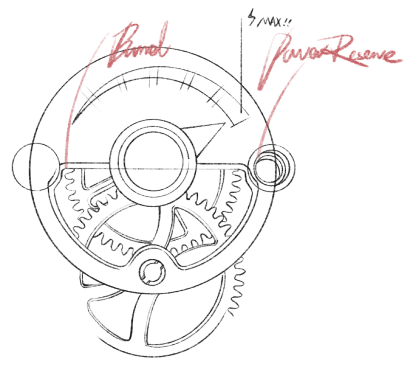

## 驚鴻之笏 11G/20G

“驚鴻之笏”是貝倫斯BEHRENS品牌「創想家INVENTOR」系列的錶款，這是一個充分展現貝倫斯BEHRENS驚人創造力、研發和製錶能力的系列。

「驚鴻之笏」設計靈感源自中國古代大臣上殿面君時的工具笏板。這是一種中國古代文武大臣上朝時使用的用以記錄君命或旨意的工具，有時也會將要對君王上奏的內容記錄在笏板上，以防遺忘。

腕錶突破了傳統機械錶的重量桎梏，做到了至輕如鴻。全新自研「BM02」機心，將錶殼和機芯融為一體，讓所有部件在非平面上實現完美傳動，展現了貝倫斯登峰造極的製錶能力。同時，「笏形」錶殼更符合人體工學，讓配戴更為舒適。

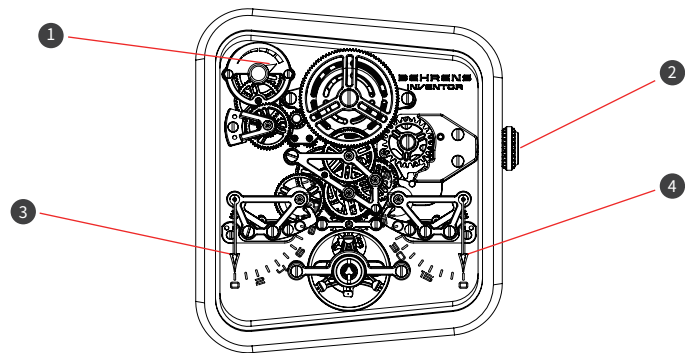

- |   |    |     |   |    |
|---|----|-----|---|----|
| ① | 動儲 | --- | ② | 錶冠 |
| ③ | 小時 | --- | ④ | 分鐘 |

## 驚鴻之笏調校方法

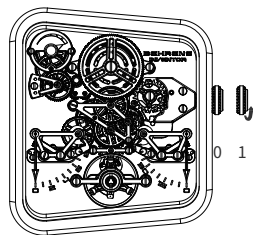

0 - 初始位置    1 - 調教時間

### 初始位置 (位置 0)

錶冠正常情况下處於此位置時，此狀態可確保腕錶防水30米。

### 手動上鍊 (位置 0)

手動順時針旋轉錶冠便可給腕錶上鍊，逆時針旋轉是無效操作，無法為腕錶提供動力。如腕錶已停止運作或是首次調校，旋轉錶冠直至錶盤左上角的動力儲備顯示裝置顯示腕錶有足夠動力。

### 調校時間 (位置 1)

輕輕拉出錶冠並至位置 1，順時針旋轉即可調校分鐘及小時時間。

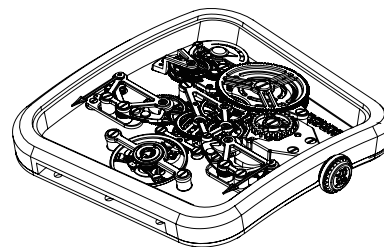

貝倫斯BM02機心

### 規格：

零件數:242件    寶石數:41顆  
厚度:5.2MM    振頻:28800A/H (4Hz)

### 特性：

手動上鍊機心    時，分雙逆跳顯示  
腕錶左上方動儲顯示，38小時動儲

## 錶帶系統

驚鴻之笏腕錶的錶帶為固定式，長度相同。  
如需更換請聯絡品牌官方協助操作。

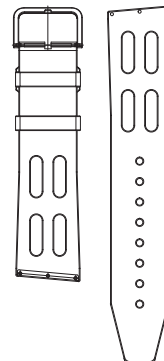

貝倫斯BEHRENS所有腕錶從您購買之日起享有三年國際保固。此外，您也可以透過貝倫斯BEHRENS官方網站登記延保至5年。

當手表需要保固時，您必須出示保固卡才能享有保固服務，該卡必須在您購買手表時，由官方或授權的代理商正式填寫才有效，包括售出日期和印章。

貝倫斯BEHRENS為全球售出的腕錶提供專業售後服務，確保腕錶的走時可靠及防水性能。

目前，貝倫斯BEHRENS位於中國深圳的總部是唯一的全球售後服務中心，建議您定期將腕錶送往貝倫斯BEHRENS服務中心接受專業的售後服務。

我們對每款手表的必備零件都備有庫存，因此可以保證多年後對手表進行維修。以上的承諾適用於每一塊貝倫斯BEHRENS手表，我們為我們產品的耐久性而自豪。

## 下列情況不屬於免費保固範圍：

- 1、遺失、竊盜或其他因火災、地震等災害而導致的瑕疵和損壞；
- 2、由於誤用、疏忽或因為意外事故而導致的瑕疵和損壞；
- 3、由於不正當使用(敲打、撞擊、擠壓等)，擅自改動或未經由貝倫斯BEHRENS授權的任何人修理，或因使用貝倫斯BEHRENS未建議的零件而導致的瑕疵和瑕疵損壞；
- 4、由於正常磨損而產生的瑕疵和損壞；為確保本國際保固的有效性，對該表所做的任何維護與修理均由貝倫斯BEHRENS授權的維修中心進行。

## 保養注意事項

### ❶ 防水性能：

您的腕錶在交貨前已通過防水深達3巴以上的壓力檢查。這可確保腕錶在濺到水或接觸到大量水時受到保護。但是，您的腕錶並不適合在洗澡、桑拿等情況下使用，否則可能會造成進水。

### ❷ 避免撞擊：

機械腕錶為精密的智慧傑作，並非越高價越堅不可摧。相反，越精密的機械腕錶越容易收到影響。因此，配戴腕錶時，應避免劇烈撞擊和震動。

### ❸ 注意防磁：

磁場會影響腕錶的正常性能。雖然磁場不會直接損害腕錶，仍可能影響腕錶的精準度，甚或導致腕錶停止運轉。最常見的磁場源自手機、磁性腕帶、袋扣、揚聲器、電腦和各種家用電器。此情況屬免費維修範圍，貝倫斯可為腕錶進行檢查及消除磁場影響。

### ❹ 避免刮碰：

若您的腕錶與手鏈、首飾或其他硬物觸碰時，可能會在金屬錶殼留下刮痕，特別是K金錶殼。

## 全球銷售網絡

貝倫斯BEHRENS特約零售商遍佈全球，由具備專業知識及精湛技藝，且經過精心挑選的合作夥伴為您效勞。歡迎瀏覽 [behrenswatches.com](http://behrenswatches.com) 了解我們的全球授權合作夥伴資訊。



對於本手冊所刊載錶款規格等信息, 貝倫斯BEHRENS保留修改權利。

7th floor, Yi'an Zhifu Building, intersection of Huangge Road and Qinghui Road, Longcheng Street, Longgang District,  
Shenzhen, China,518172

[behrenswatches.com](http://behrenswatches.com)

